

75

Immersion heaters for light metals

Thermoplongeurs pour métaux non-ferreux

Supratherm Dual 75

Available power ratings

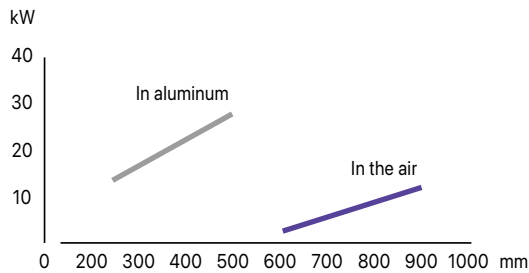

The power ratings range from 2 to 12kW in the air and from 14 to 27kW in aluminum at 700°C, corresponding to heating lengths from 250mm to 900mm.

Uses

Pre-heating furnaces together with heating and temperature holding of light liquid metals in:

- Melting-Holding furnaces for Gigafactories
- Holding furnaces
- Degassing units
- Transport ladles

Advantages

The Supratherm Dual 75 immersion heaters family offers the possibility to preheat empty furnace with the long heating length before it is filled with aluminum. The short heating length plays then a classical immersion heater role and regulates temperature, without creating overheated zones.

It also helps your factory reach energy saving and decarbonization goals.

Atherm's thermal solutions can be fully customized. Accordingly, the Supratherm Dual 75 line offers a wide range of power ratings, by selecting immersion heaters of various lengths. Our experts help to scale the project and to choose the solution that meets the best client's needs.

The Supratherm Dual 75 immersion heater comes with a 1-year guarantee*.



ENERGY SAVINGS

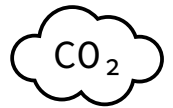

DECARBONIZATION

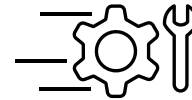

SHORT MAINTENANCE TIME



HIGH QUALITY ALLOYS

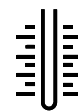

PREHEATING



QUICK RE-HEATING

ø75mm

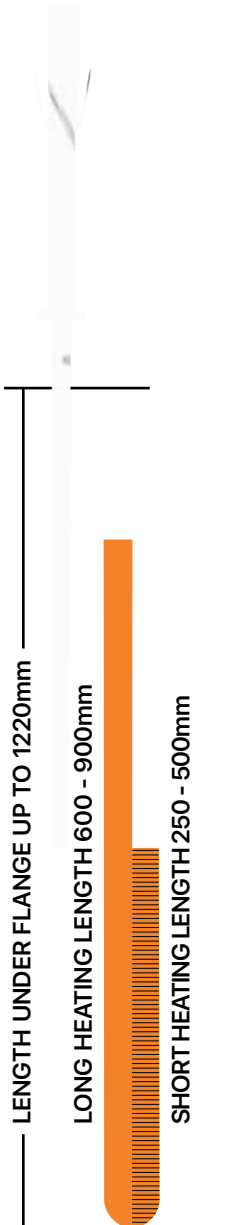

and other special non-ferrous alloys

*This guarantee is issued once our technical experts have validated the project.



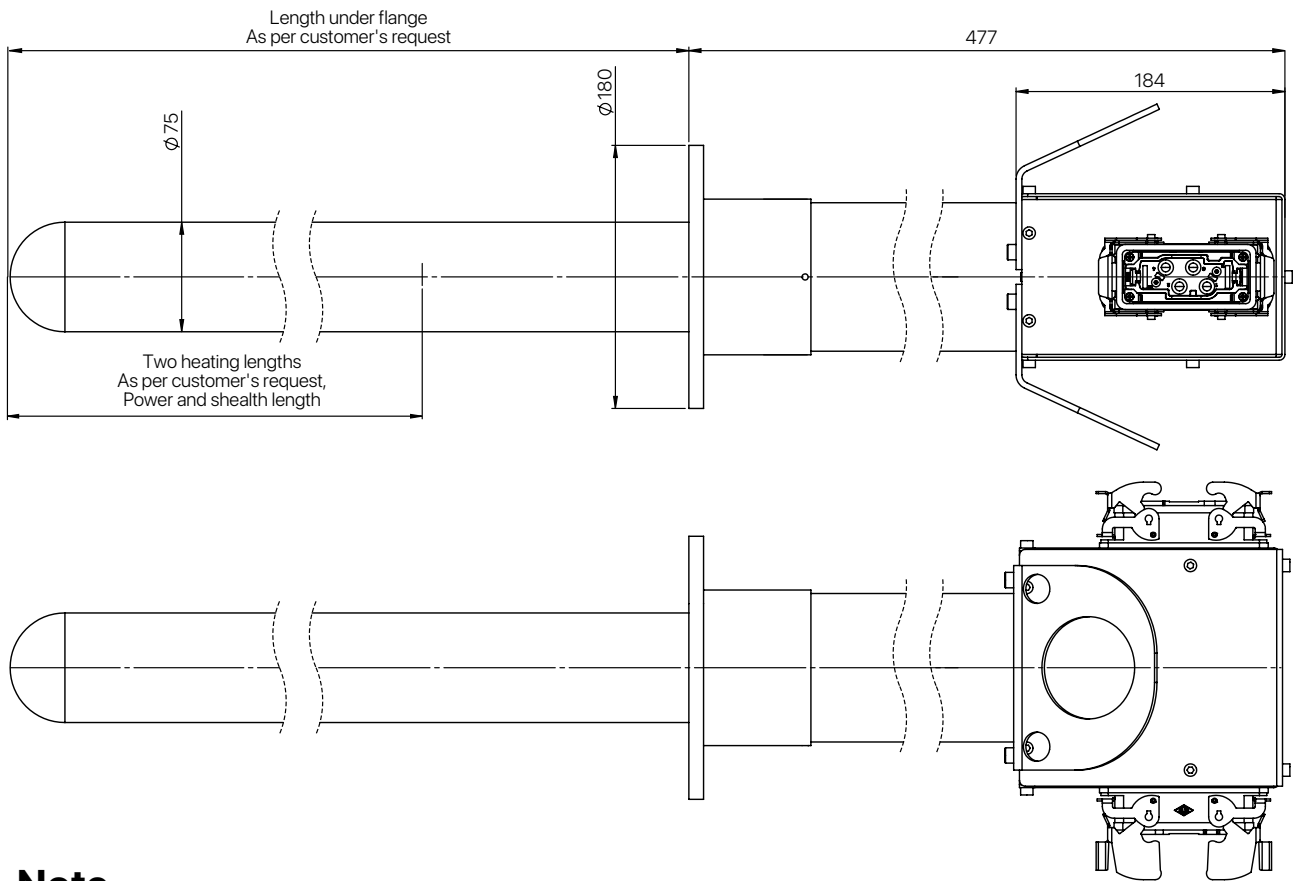

Note

- Heat transfer: radiative and conductive
- Resistance: Nickel Chromium
- Sheath: Sialon
- Power supply: adaptable, no transformer needed

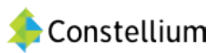

Your thermal solutions partner

Atherm - FRANCE / www.atherm.com / commercial@atherm.net

Supratherm Dual 75

A game changer for furnaces
and for managing metal levels in baths.

The Supratherm Dual 75 is a brand-new model from Atherm's innovation lab, launched in 2023 to meet the needs of our most demanding customers. This unique electrical immersion heater, has been designed for two-tier operations. This new feature can be used in two different ways.

1/ To preheat furnaces

The long heating length is used when the furnace is empty. It first dries then heats the refractory material, along with the atmosphere, in preparation for the filling phase.

The long heating length can also be used to heat a furnace only partially filled with aluminum, for example during the filling phase. This feature is a true game-changer for furnaces.

The short heating length takes over as soon as it is completely immersed in liquid aluminum. It then delivers the maximum possible power in the molten metal, permitting temperature holding and melting, in the same way as Atherm's other Supratherm heaters.

2/ To improve furnace filling flexibility

The long heating length is used when the molten metal levels are high, while the short one delivers its full potential when the metal levels are lower. By changing the heating length, the Supratherm Dual 75 better tolerates the variations in bath-depth, increasing time between filling baths.

The Supratherm Dual 75 is nevertheless very simple to use. Since it is equipped with two independent power plugs, everything operates as if you had two classical Supratherm immersion heaters that need to be switched on or off depending on the bath level.

Like all Atherm immersion heaters, the Supratherm Dual 75 can be customised, by varying heating lengths, depending on the specific needs of each client.

